

PRO- ODO 3.0

- IT** **Profilo in alluminio ossidato per incasso** - Tagliabile a misura; si abbina a terminali di chiusura in policarbonato (opzionali).
- EN** **Oxidized aluminium profile for flush mounting** - Cuttable to size; it combines with polycarbonate end caps (optional).
- DE** **Einbauprofil aus eloxiertem Aluminium** - Kürzbar und kombinierbar mit Endkappen aus Polycarbonat (optional).

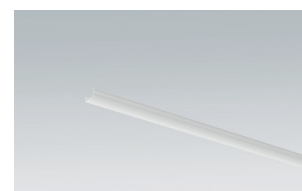

Ⓐ Schermo
Screen / Abdeckung

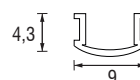
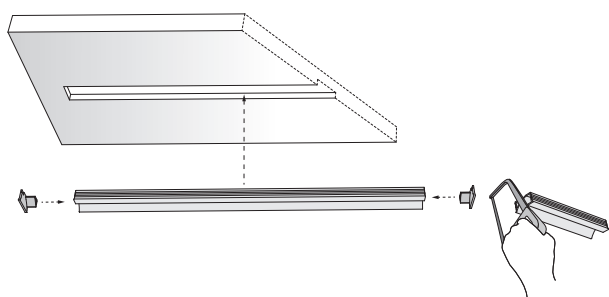
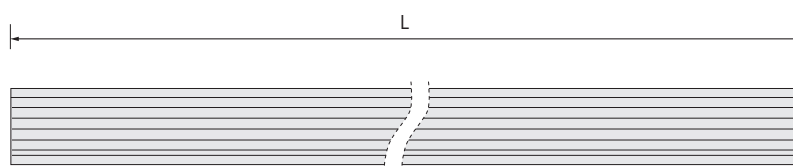
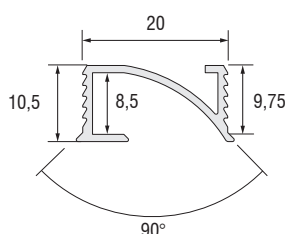
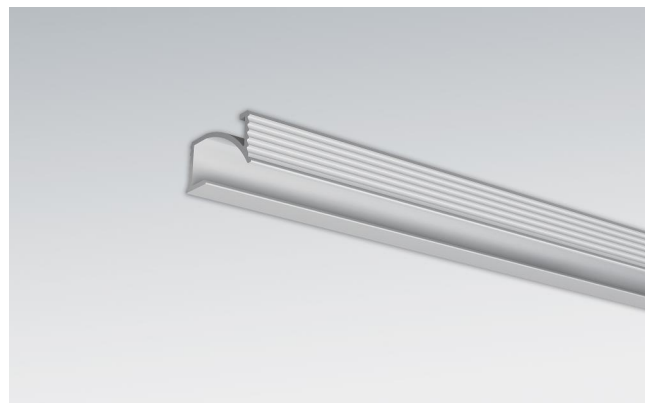
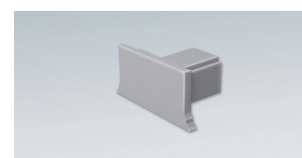
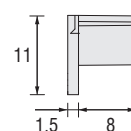

Ⓑ Terminali
End covers / Endkappen

| Profilo - Profile - Profil | |
|------------------------------------|---------------------------------|
| L | Codice - Part no. - Artikel-Nr. |
| 2000 | 6620P2000 |
| 3000 | 6620P3000 |
| Schermo - Screen - Abdeckung | |
| L | Codice - Part no. - Artikel-Nr. |
| 2000 | 6620S2000 |
| 3000 | 6620S3000 |
| Terminali - End covers - Endkappen | |
| PCS | Codice - Part no. - Artikel-Nr. |
| PAIR | 6620T0001 |

Dimensioni in millimetri (mm) / Dimensions in Millimeters (mm) / Dimensionen in Millimetern (mm)